

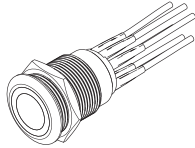

**PB19VB\_6FS - PB19VB\_6FSI - PB19VB\_6FBE - PB19VB\_6FBL**

COMPOSITION DES KITS / BILL OF MATERIAL				
				
	PB19VB_6FS	PBP19_3	PBP19_4	PBP19_B
PB19VB_6FSI	1 x	1 x	/	/
PB19VB_6FBE	1 x	/	1 x	/
PB19VB_6FBL	1 x	/	/	1x

CARACTÉRISTIQUES TECHNIQUES - TECHNICAL SPECIFICATIONS

Caractéristiques générales du bouton poussoir - General specifications of the push button

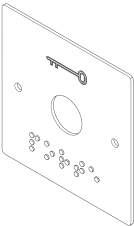
Tension d'alimentation / Operating voltage : 12V DC
Pouvoir de coupure / Switching capacity : 250V AC - 2 A / 24V DC - 1 A
Type de bouton / Button type : NO+NC
Température de fonctionnement / Operating temperature : -25 + 55°C
Indice de protection / IP rating : IP 65
Longueur des fils / Wire length : 15 cm
Couleur de la LED / LED colour : Blanc-Vert / White-Green
Diamètre de filetage / Thread diameter : Ø19 mm
Section des conducteurs / Conductor cross-section : AWG 22
Diamètre extérieur des fils / External wire diameter : Ø1,70 mm

L'indice de protection concerne uniquement la face avant du bouton  
The IP rate relates only to the front face



Consignes de tri pouvant varier localement : [www.consignesdetri.fr](http://www.consignesdetri.fr)

[www.sewosy.com](http://www.sewosy.com)

Les indications, photographies, images ou schémas présents sur cette notice n'engagent pas la société SEWOSY et n'ont aucune valeur contractuelle  
The informations, photographs, images, drawings contained in this leaflet does not engage the responsibility of SEWOSY and have no contractual value

RACCORDEMENT - CONNECTION

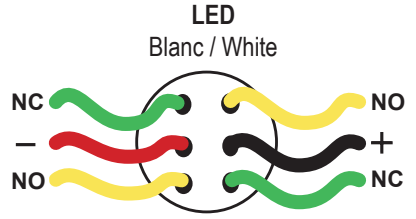
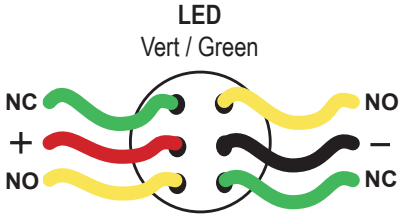

**12V DC uniquement / 12V DC only**

Inverser la polarité du bouton poussoir afin de modifier la couleur de la LED.  
*Reverse the polarity of the push button to change the colour of the LED.*

DIMENSIONS

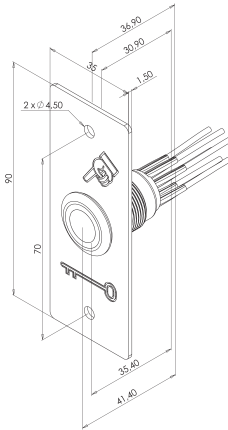

**PB19VB\_6FSI**

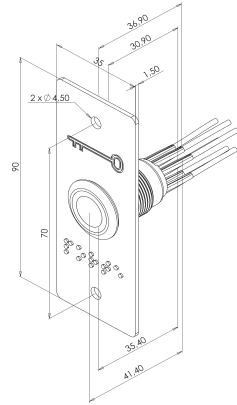

**PB19VB\_6FBE**

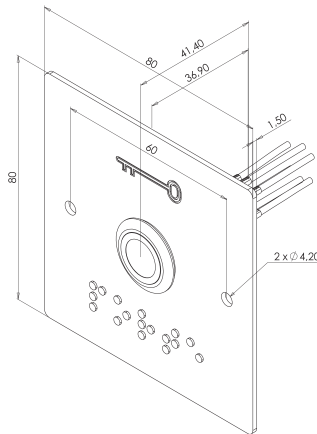

**PB19VB\_6FBL**